

TEST REPORT

CERTIFICATE OF CONFORMITY

Standard: 47 CFR FCC Part 15, Subpart B, Class A

ANSI C63.4-2014

ANSI C63.4a-2017

Report No.: FDBDBO-WTW-P23120002

Product: High-Performance Fanless System

Brand: Vecow

Model No.: IVX-1000-ICY

Series Model: IVX-1XXXXXXXXXXXXXXXXX ("X" can be 0-9, A-Z or blank for marketing purpose)

Received Date: 2023/12/1

Test Date: 2023/12/11 ~ 2023/12/12

Issued Date: 2024/7/15

Applicant: Vecow Co., Ltd.

Address: 3F., No. 10, Jiankang Rd., Zhonghe Dist., New Taipei City 23586, Taiwan

Issued By: Bureau Veritas Consumer Products Services (H.K.) Ltd., Taoyuan Branch
Lin Kou Laboratories

Lab Address: No. 47-2, 14th Ling, Chia Pau Vil., Lin Kou Dist., New Taipei City, Taiwan

Test Location: No. 47-2, 14th Ling, Chia Pau Vil., Lin Kou Dist., New Taipei City, Taiwan

FCC Registration /

Designation Number: 418586 / TW1078

Approved by: _____



Jim Hsiang / Associate Technical Manager

Date: _____

2024/7/15

This test report consists of 27 pages in total. It may be duplicated completely for legal use with the approval of the applicant. It should not be reproduced except in full, without the written approval of our laboratory. The test results in the report only apply to the tested sample. The test results in this report are traceable to the national or international standards.

Prepared by : Vivian Chen / Senior Specialist



This report is governed by, and incorporates by reference, the Conditions of Testing as posted at the date of issuance of this report at <http://www.bureauveritas.com/home/about-us/our-business/cps/about-us/terms-conditions/>, and is intended for your exclusive use. Any copying or replication of this report to or for any other person or entity, or use of our name or trademark, is permitted only with our prior written permission. This report sets forth our findings solely with respect to the test samples identified herein. The results set forth in this report are not indicative or representative of the quality or characteristics of the lot from which a test sample was taken or any similar or identical product unless specifically and expressly noted. Our report includes all of the tests requested by you and the results thereof based upon the information that you provided to us. Measurement uncertainty is only provided upon request for accredited tests. Statements of conformity are based on simple acceptance criteria without taking measurement uncertainty into account, unless otherwise requested in writing. You have 60 days from date of issuance of this report to notify us of any material error or omission caused by our negligence or if you require measurement uncertainty; provided, however, that such notice shall be in writing and shall specifically address the issue you wish to raise. A failure to raise such issue within the prescribed time shall constitute your unqualified acceptance of the completeness of this report, the tests conducted and the correctness of the report contents.

Table of Contents

| | |
|---------------------------------------------------------------------------------|-----------|
| Release Control Record | 3 |
| 1 Certificate..... | 4 |
| 2 Summary of Test Results | 5 |
| 2.1 Measurement Uncertainty | 5 |
| 2.2 Supplementary Information | 5 |
| 3 General Information | 6 |
| 3.1 Description of EUT | 6 |
| 3.2 Primary Clock Frequencies of Internal Source..... | 6 |
| 3.3 Features of EUT | 6 |
| 3.4 Operating Modes of EUT and Determination of Worst Case Operating Mode | 7 |
| 3.5 Test Program Used and Operation Descriptions | 7 |
| 3.6 Connection Diagram of EUT and Peripheral Devices | 8 |
| 3.7 Configuration of Peripheral Devices and Cable Connections | 9 |
| 4 Test Instruments | 11 |
| 4.1 Conducted Emissions from Power Ports..... | 11 |
| 4.2 Radiated Emissions up to 1 GHz | 12 |
| 4.3 Radiated Emissions above 1 GHz..... | 13 |
| 5 Limits of Test Items..... | 14 |
| 5.1 Conducted Emissions from Power Ports..... | 14 |
| 5.2 Radiated Emissions up to 1 GHz | 14 |
| 5.3 Radiated Emissions above 1 GHz..... | 14 |
| 6 Test Arrangements..... | 15 |
| 6.1 Conducted Emissions from Power Ports..... | 15 |
| 6.2 Radiated Emissions up to 1 GHz | 16 |
| 6.3 Radiated Emissions above 1 GHz..... | 17 |
| 7 Test Results of Test Item | 18 |
| 7.1 Conducted Emissions from Power Ports..... | 18 |
| 7.2 Radiated Emissions up to 1 GHz | 20 |
| 7.3 Radiated Emissions above 1 GHz..... | 22 |
| 8 Pictures of Test Arrangements | 24 |
| 8.1 Conducted Emissions from Power Ports..... | 24 |
| 8.2 Radiated Emissions up to 1 GHz | 25 |
| 8.3 Radiated Emissions above 1 GHz..... | 26 |
| 9 Information of the Testing Laboratories | 27 |



Release Control Record

| Issue No. | Description | Date Issued |
|----------------------|-------------------|-------------|
| FDBDBO-WTW-P23120002 | Original release. | 2024/7/15 |

1 Certificate

Product: High-Performance Fanless System

Brand: Vecow

Test Model: IVX-1000-ICY

Series Model: IVX-1XXXXXXXXXXXXXXXXX (“X” can be 0-9, A-Z or blank for marketing purpose)

Sample Status: Mass Production

Applicant: Vecow Co., Ltd.

Test Date: 2023/12/11 ~ 2023/12/12

Standard: 47 CFR FCC Part 15, Subpart B, Class A
ANSI C63.4–2014
ANSI C63.4a–2017

The above equipment has been tested by **Bureau Veritas Consumer Products Services (H.K.) Ltd., Taoyuan Branch**, and found compliance with the requirement of the above standards. The test record, data evaluation & Equipment Under Test (EUT) configurations represented herein are true and accurate accounts of the measurements of the sample’s EMC characteristics under the conditions specified in this report.

2 Summary of Test Results

The test items that the EUT need to perform in accordance with its interfaces, evaluated functions, are as follows:

| Standard / Clause | Test Item | Result | Remark |
|-------------------|--------------------------------------|--------|------------------------------------------------------------|
| FCC Part 15.107 | Conducted Emissions from Power Ports | Pass | Minimum passing Class A margin is -15.23 dB at 9.51130 MHz |
| FCC Part 15.109 | Radiated Emissions up to 1 GHz | Pass | Minimum passing Class A margin is -1.89 dB at 220.63 MHz |
| FCC Part 15.109 | Radiated Emissions above 1 GHz | Pass | Minimum passing Class A margin is -0.68 dB at 6000.02 MHz |

Note: Determining compliance based on the results of the compliance measurement, not taking into account measurement instrumentation uncertainty.

2.1 Measurement Uncertainty

Where relevant, the following measurement uncertainty levels have been estimated for tests performed on the EUT as specified in CISPR 16-4-2:

| Measurement | Specification | Expanded Uncertainty (k=2) (±) | Maximum allowable uncertainty (±) |
|--------------------------------------|----------------|--------------------------------|-----------------------------------|
| Conducted Emissions from Power Ports | 9 kHz ~ 30 MHz | 2.90 dB | 3.4 dB (U_{CISPR}) |
| Radiated Emissions up to 1 GHz | 30 MHz ~ 1 GHz | 3m: 5.46 dB 10m: 4.04 dB | 6.3 dB (U_{CISPR}) |
| | 1 GHz ~ 6 GHz | 4.72 dB | 5.2 dB (U_{CISPR}) |
| Radiated Emissions above 1 GHz | 6 GHz ~ 18 GHz | 4.68 dB | 5.5 dB (U_{CISPR}) |

The other instruments specified are routine verified to remain within the calibrated levels, no measurement uncertainty is required to be calculated.

2.2 Supplementary Information

There is not any deviation from the test standards for the test method, and no modifications required for compliance.

3 General Information

3.1 Description of EUT

| | |
|---------------------|-----------------------------------------------------------------------------|
| Product | High-Performance Fanless System |
| Brand | Vecow |
| Test Model | IVX-1000-ICY |
| Series Model | IVX-1XXXXXXXXXXXXXXXXX ("X" can be 0-9, A-Z or blank for marketing purpose) |
| Model Difference | For Marketing Differentiation |
| Sample Status | Mass Production |
| Operating Software | WIN 10, BURNINTEST |
| Power Supply Rating | DC from Adapter |
| Accessory Device | Adapter |
| Data Cable Supplied | N/A |

Note:

The EUT uses following adapter.

| Brand | Model | Specification |
|--------|-------------|--------------------------------------------------------------------------------------------------------|
| LITEON | PA-1181-28E | AC Input: 100-240V, 2.34A, 50-60Hz (3pin) DC Output: 24V, 7.5A 180W (1.5m, with two ferrite cores.) |

3.2 Primary Clock Frequencies of Internal Source

The highest frequency generated or used within the EUT or on which the EUT operates or tunes is 1.4 GHz, provided by Vecow Co., Ltd., for detailed internal source, please refer to the manufacturer's specifications.

3.3 Features of EUT

The tests reported herein were performed according to the method specified by Vecow Co., Ltd., for detailed feature description, please refer to the manufacturer's specifications or user's manual.

Please refer to appendix of the report if the applicant has provided additional descriptions of the EUT.

The EUT configured with the following key components:

| Component | Specification |
|-----------|------------------------------------------|
| CPU | 13th Gen Intel® Core™ i7-13700TE@1.10GHz |
| RAM | INNODISK DDR5 4800 32GB W/T SODIMM x 2 |
| SSD | INNODISK 2.5" SATA SSD 3TE7 512GB x 6 |

3.4 Operating Modes of EUT and Determination of Worst Case Operating Mode

Test modes are presented in the report as below.

| Test Condition | |
|----------------|---------------------------------------------------------------------------------------------------------------------------------------------------------------|
| Mode | Conducted Emissions from Power Ports |
| A | HDMI*2:1920*1080/60Hz + VGA:1920*1080/60Hz + with adapter + Lan 3 ~Lan 10: with load & link + Lan 2: 2.5G link + Lan 1: 1G link + Input Power(120 Vac, 60 Hz) |
| Mode | Radiated Emissions up to 1 GHz |
| A | HDMI*2:1920*1080/60Hz + VGA:1920*1080/60Hz + with adapter + Lan 3~Lan 10: with load & link + Lan 2: 2.5G link + Lan 1: 1G link + Input Power(120 Vac, 60 Hz) |
| Mode | Radiated Emissions above 1 GHz |
| A | HDMI*2:1920*1080/60Hz + VGA:1920*1080/60Hz + with adapter + Lan 3~Lan 10: with load & link + Lan 2: 2.5G link + Lan 1: 1G link + Input Power(120 Vac, 60 Hz) |

3.5 Test Program Used and Operation Descriptions

- a. Turned on the power of all equipment.
- b. EUT ran a test program (BurnIntest) to enable all functions.
- c. EUT read and wrote messages to/ from internal storage devices and external storage devices.
- d. Laptop/ PC (kept at remote area) sent and received messages to/ from EUT via LAN cable.
- e. EUT sent (H) messages to monitors. Then they displayed messages on their screens simultaneously.
- f. EUT sent messages to printer and the printer printed them out.
- g. EUT sent (1kHz audio) signal to earphone
- h. Steps c-g were repeated.

3.6 Connection Diagram of EUT and Peripheral Devices

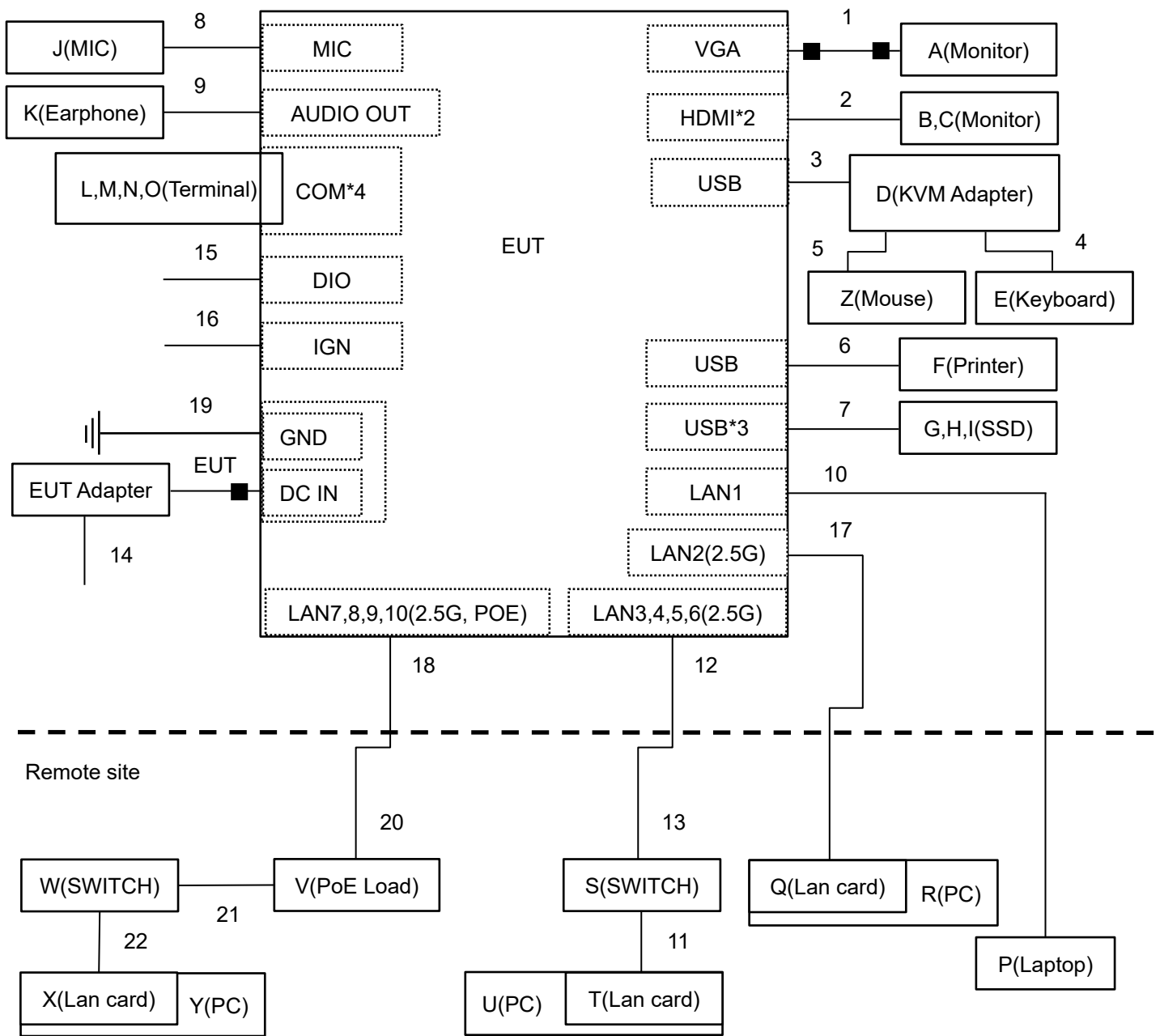

3.7 Configuration of Peripheral Devices and Cable Connections

| ID | Product | Brand | Model No. | Serial No. | FCC ID | Remarks |
|----|--------------------|---------|------------------------|--------------------------|--------------|-----------------------|
| A | Monitor | DELL | U2410 | CN082WXD728720CC0HLL | DoC | Provided by Lab |
| B | Monitor | DELL | U2410 | CN082WXD728720CC0KVL | DoC | Provided by Lab |
| C | Monitor | DELL | U2410 | CN082WXD728720CC0LGL | DoC | Provided by Lab |
| D | KVM Adapter | N/A | N/A | N/A | N/A | Supplied by applicant |
| E | USB Keyboard | Dell | KB216t | CN-0W33XP-LO300-7CL-1903 | N/A | Provided by Lab |
| F | PRINTER | HP | HP Officejet Pro 251dw | CN62OCV0JN | B94SDGOB1191 | Provided by Lab |
| G | USB 3.1 SSD | Crucial | CT500X8SSD9 | 1941E3201117 | N/A | Provided by Lab |
| H | USB 3.1 SSD | Crucial | CT500X8SSD9 | 1940E3200AD3 | N/A | Provided by Lab |
| I | USB 3.1 SSD | Crucial | CT500X8SSD9 | 1942E32014B5 | N/A | Provided by Lab |
| J | Microphone | E-books | E-EPB099 | N/A | N/A | Provided by Lab |
| K | EARPHONE | PHILIPS | SBC HL150 | H2010150 | N/A | Provided by Lab |
| L | Terminal | N/A | N/A | N/A | N/A | Supplied by applicant |
| M | Terminal | N/A | N/A | N/A | N/A | Supplied by applicant |
| N | Terminal | N/A | N/A | N/A | N/A | Supplied by applicant |
| O | Terminal | N/A | N/A | N/A | N/A | Supplied by applicant |
| P | Laptop | LENOVO | T480 | PF1EZSA2 | N/A | Provided by Lab |
| Q | LAN CARD_10G_PCIE | ASUS | XG-C100C | N/A | DoC | Provided by Lab |
| R | PC | DELL | 3010 SF | N/A | N/A | Provided by Lab |
| S | 10G NETWORK SWITCH | NETGEAR | XS508M | 52J22974D07E1 | N/A | Provided by Lab |
| T | LAN CARD_10G_PCIE | ASUS | XG-C100C | N/A | DoC | Provided by Lab |
| U | Desktop PC | DELL | 3010 SF | CHWQS02 | N/A | Provided by Lab |
| V | POE LOAD | N/A | N/A | N/A | N/A | Supplied by applicant |
| W | SWITCH | TP-LINK | TL-SX105 | N/A | DoC | Provided by Lab |
| X | LAN CARD_10G_PCIE | ASUS | XG-C100C | N/A | DoC | Provided by Lab |
| Y | PC | DELL | 3010 SF | N/A | N/A | Provided by Lab |
| Z | USB Mouse | DELL | MOCZUL | CN-049TWY-PRC00-77B-0083 | N/A | Provided by Lab |

| ID | Cable Descriptions | Qty. | Length (m) | Shielding (Yes/No) | Cores (Qty.) | Remarks |
|----|-----------------------|------|------------|--------------------|--------------|-----------------------|
| 1 | VGA cable | 1 | 1.8 | Yes | 2 | Provided by Lab |
| 2 | HDMI cable | 2 | 2 | Yes | 0 | Provided by Lab |
| 3 | USB cable | 1 | 2 | Yes | 0 | Supplied by applicant |
| 4 | USB cable | 1 | 1.8 | Yes | 0 | Provided by Lab |
| 5 | USB cable | 1 | 1.8 | Yes | 0 | Provided by Lab |
| 6 | USB cable | 1 | 1.8 | Yes | 0 | Provided by Lab |
| 7 | USB Type A to C cable | 3 | 1 | Yes | 0 | Provided by Lab |
| 8 | Audio cable | 1 | 2 | No | 0 | Provided by Lab |
| 9 | Audio cable | 1 | 1.2 | No | 0 | Provided by Lab |
| 10 | RJ45 (Cat. 5e) cable | 1 | 10 | Yes | 0 | Provided by Lab |
| 11 | RJ45 (Cat. 5e) cable | 1 | 3 | Yes | 0 | Provided by Lab |
| 12 | RJ45 (Cat. 5e) cable | 4 | 2 | Yes | 0 | Supplied by applicant |
| 13 | RJ45 (Cat. 5e) cable | 4 | 10 | Yes | 0 | Provided by Lab |
| 14 | AC power cable | 1 | 1.8 | No | 0 | Provided by Lab |
| 15 | Data cable | 1 | 1.5 | No | 0 | Provided by Lab |
| 16 | Data cable | 1 | 1.5 | No | 0 | Provided by Lab |
| 17 | RJ45 (Cat. 5e) cable | 1 | 10 | Yes | 0 | Provided by Lab |
| 18 | RJ45 (Cat. 5e) cable | 4 | 2 | Yes | 0 | Supplied by applicant |
| 19 | GND (PE) cable | 1 | 1.5 | No | 0 | Provided by Lab |
| 20 | RJ45 (Cat. 5e) cable | 4 | 10 | Yes | 0 | Provided by Lab |
| 21 | RJ45 (Cat. 5e) cable | 4 | 3 | Yes | 0 | Provided by Lab |
| 22 | RJ45 (Cat. 5e) cable | 1 | 3 | Yes | 0 | Provided by Lab |

4 Test Instruments

The calibration interval of the all test instruments are 12 months and the calibrations are traceable to NML/ROC and NIST/USA.

4.1 Conducted Emissions from Power Ports

| Description Manufacturer | Model No. | Serial No. | Calibrated Date | Calibrated Until |
|--------------------------------------|---------------|---------------|--------------------|---------------------|
| 50 ohm terminal resistance LYNICS | 0900510 | E1-011285 | 2023/9/21 | 2024/9/20 |
| | | E1-011286 | 2023/9/21 | 2024/9/20 |
| 50 ohm terminal resistance SUHNER | 65BNC-5001 | E1-010789 | 2023/6/16 | 2024/6/15 |
| EMI Test Receiver R&S | ESCI | 100412 | 2023/8/23 | 2024/8/22 |
| | ESCS 30 | 100276 | 2023/4/20 | 2024/4/19 |
| Fixed Attenuator STI | STI02-2200-10 | NO.1 | 2023/9/13 | 2024/9/12 |
| LISN R&S | ENV216 | 101196 | 2023/5/22 | 2024/5/21 |
| | | 101197 | 2023/7/12 | 2024/7/11 |
| LISN Schwarzbeck | NNLK 8121 | 8121-731 | 2023/6/9 | 2024/6/8 |
| | | 8121-00759 | 2023/8/21 | 2024/8/20 |
| | | 8121-808 | 2023/5/2 | 2024/5/1 |
| | NNLK 8129 | 8129229 | 2023/6/27 | 2024/6/26 |
| RF Coaxial Cable PEWC | 5D-FB | Cable-CO10-01 | 2023/2/8 | 2024/2/7 |
| Software BVADT | Cond_V7.3.7.4 | N/A | N/A | N/A |

Notes:

1. The test was performed in Linkou Conduction 10.
2. The VCCI Site Registration No. C-11852.
3. Tested Date: 2023/12/12

4.2 Radiated Emissions up to 1 GHz

| Description Manufacturer | Model No. | Serial No. | Calibrated Date | Calibrated Until |
|----------------------------------------------|------------------|--------------|--------------------|---------------------|
| Bi_Log Antenna Schwarzbeck | VULB 9168 | 9168-717 | 2023/10/16 | 2024/10/15 |
| | | 9168-718 | 2023/10/16 | 2024/10/15 |
| Coupling / Decoupling Network Schwarzbeck | CDNE-M2 | 00097 | 2023/5/25 | 2024/5/24 |
| | CDNE-M3 | 00091 | 2023/5/25 | 2024/5/24 |
| EMI Test Receiver R&S | ESR3 | 102983 | 2023/5/18 | 2024/5/17 |
| | | 102984 | 2023/6/15 | 2024/6/14 |
| Fixed Attenuator Mini-Circuits | UNAT-5+ | PAD-CH8-01 | 2023/9/22 | 2024/9/21 |
| | | PAD-CH8-02 | 2023/9/22 | 2024/9/21 |
| Preamplifier EMCI | EMC9135 | 980326 | 2023/2/16 | 2024/2/15 |
| | | 980327 | 2023/2/16 | 2024/2/15 |
| RF Coaxial Cable JYBAO | LMR-600 | Cable-CH8-01 | 2023/9/22 | 2024/9/21 |
| | | Cable-CH8-02 | 2023/9/22 | 2024/9/21 |
| RF Coaxial Cable Pacific | 8D-FB | Cable-CH8-03 | 2023/9/22 | 2024/9/21 |
| Software BVADT | Radiated_V8.7.08 | N/A | N/A | N/A |
| Tower Max Full. | MF7802 | MF780208105 | N/A | N/A |
| Turn Table & Tower Max Full. | MF7802 | MF7802121 | N/A | N/A |

Notes:

1. The test was performed in Linkou 10M Chamber (Chamber 8) , The test site validated date: 2023/8/26 (NSA)
2. The VCCI Site Registration No. R-12946.
3. Tested Date: 2023/12/12

4.3 Radiated Emissions above 1 GHz

| Description Manufacturer | Model No. | Serial No. | Calibrated Date | Calibrated Until |
|--------------------------------------------|------------------|------------------|--------------------|---------------------|
| Band Pass Filter Micro-Tronics | BRM17690 | 005 | 2023/5/25 | 2024/5/24 |
| Fix tool for Boresight antenna tower BV | BAF-01 | 4 | N/A | N/A |
| Fixed Attenuator Mini-Circuits | BW-K3-2W44+ | PAD-CH7-03 | 2023/7/6 | 2024/7/5 |
| | BW-N4W5+ | PAD-CH7-02 | 2023/7/6 | 2024/7/5 |
| Horn Antenna EMCO | 3115 | 9312-4192 | 2023/11/12 | 2024/11/11 |
| Horn Antenna ETS-Lindgren | 3117-PA | 00215857 | 2023/11/12 | 2024/11/11 |
| Horn Antenna Schwarzbeck | BBHA-9170 | BBHA9170190 | 2023/11/12 | 2024/11/11 |
| MXA Signal Analyzer Keysight | N9020B | MY60110438 | 2023/11/28 | 2024/11/27 |
| | | MY60112260 | 2023/5/24 | 2024/5/23 |
| Notch Filter Micro-Tronics | BRC50703-01 | 010 | 2023/5/25 | 2024/5/24 |
| Preamplifier EMCI | EMC0126545 | 980076 | 2023/2/16 | 2024/2/15 |
| | | 980175 | 2023/9/2 | 2024/9/1 |
| | | 980235 | 2023/2/16 | 2024/2/15 |
| Preamplifier HP | 8449B | 3008A01292 | 2023/2/16 | 2024/2/15 |
| PSA Spectrum Analyzer Agilent | E4446A | MY51100009 | 2023/6/21 | 2024/6/20 |
| RF Coaxial Cable EMEC | EM102-KMKM | 01 | 2023/7/6 | 2024/7/5 |
| RF Coaxial Cable HUBER+SUHNER | SF-102 | Cable-CH7(3m)-02 | 2023/7/6 | 2024/7/5 |
| Software BVADT | Radiated_V8.7.08 | N/A | N/A | N/A |
| Turn Table & Tower Max Full | MF7802 | MF780208103 | N/A | N/A |

Notes:

1. The test was performed in Linkou 966 Chamber 2 (CH 7).
2. The VCCI Site Registration No. G-10039.
3. Tested Date: 2023/12/11

5 Limits of Test Items

5.1 Conducted Emissions from Power Ports

| Frequency (MHz) | Class A (dBuV) | | Class B (dBuV) | |
|-----------------|----------------|---------|----------------|---------|
| | Quasi-peak | Average | Quasi-peak | Average |
| 0.15 - 0.5 | 79 | 66 | 66 - 56 | 56 - 46 |
| 0.50 - 5.0 | 73 | 60 | 56 | 46 |
| 5.0 - 30.0 | 73 | 60 | 60 | 50 |

Notes: 1. The lower limit shall apply at the transition frequencies.
 2. The limit decreases linearly with the logarithm of the frequency in the range of 0.15 to 0.50 MHz.

5.2 Radiated Emissions up to 1 GHz

Emissions radiated outside of the specified bands, shall be according to the general radiated limits as following:

| Radiated Emissions Limits at 10 meters (dB μ V/m) | | | | |
|-------------------------------------------------------|------------------|------------------|-------------------|-------------------|
| Frequencies (MHz) | FCC 15B, Class A | FCC 15B, Class B | CISPR 22, Class A | CISPR 22, Class B |
| 30-88 | 39.1 | 29.5 | 40 | 30 |
| 88-216 | 43.5 | 33.1 | | |
| 216-230 | 46.4 | 35.6 | | |
| 230-960 | | | 47 | 37 |
| 960-1000 | 49.5 | 43.5 | | |

| Radiated Emissions Limits at 3 meters (dB μ V/m) | | | | |
|------------------------------------------------------|------------------|------------------|-------------------|-------------------|
| Frequencies (MHz) | FCC 15B, Class A | FCC 15B, Class B | CISPR 22, Class A | CISPR 22, Class B |
| 30-88 | 49.5 | 40.0 | 50.5 | 40.5 |
| 88-216 | 54.0 | 43.5 | | |
| 216-230 | 56.9 | 46.0 | | |
| 230-960 | | | 57.5 | 47.5 |
| 960-1000 | 60.0 | 54.0 | | |

Notes: 1. The lower limit shall apply at the transition frequencies.

5.3 Radiated Emissions above 1 GHz

Frequency Range (For unintentional radiators)

| Highest frequency generated or used in the device or on which the device operates or tunes (MHz) | Upper frequency of measurement range (MHz) |
|--------------------------------------------------------------------------------------------------|--------------------------------------------------------------------|
| Below 1.705 | 30 |
| 1.705-108 | 1000 |
| 108-500 | 2000 |
| 500-1000 | 5000 |
| Above 1000 | 5th harmonic of the highest frequency or 40GHz, whichever is lower |

| Radiated Emissions Limits at 3 meters (dB μ V/m) | | |
|------------------------------------------------------|---------------------|---------------------|
| Frequency range | Class A | Class B |
| Above 1GHz | Avg: 60 Peak: 80 | Avg: 54 Peak: 74 |

Notes: 1. These limit levels apply for a measurement distance of 3 m. If using a different measurement distance, the measured levels shall be extrapolated to the 3 m limit distance using a factor of 20 dB per decade of distance. The measurement distance shall place the measurement antenna in the far field of the ITE or digital apparatus under test.

6 Test Arrangements

6.1 Conducted Emissions from Power Ports

- For the table-top EUT is placed on a 0.8 meter insulation table; for the floor standing EUT shall be insulated (by insulation of 12 mm) from the horizontal reference ground plane. The EUT is placed 0.4 meters from the conducting wall of the shielded room with EUT being connected to the power mains through a line impedance stabilization network (LISN). Other support units are connected to the power mains through another LISN. They provide coupling impedance for the measuring instrument.
- Both lines of the power mains connected to the EUT were checked for maximum conducted interference.
- The test results of conducted emissions at mains ports are recorded of six worst margins for quasi-peak (mandatory) [and average (if necessary)] values against the limits at frequencies of interest unless the margin is 20 dB or greater.

Note: The resolution bandwidth and video bandwidth of test receiver is 9kHz for quasi-peak detection (QP) and average detection (AV) at frequency 0.15MHz-30MHz.

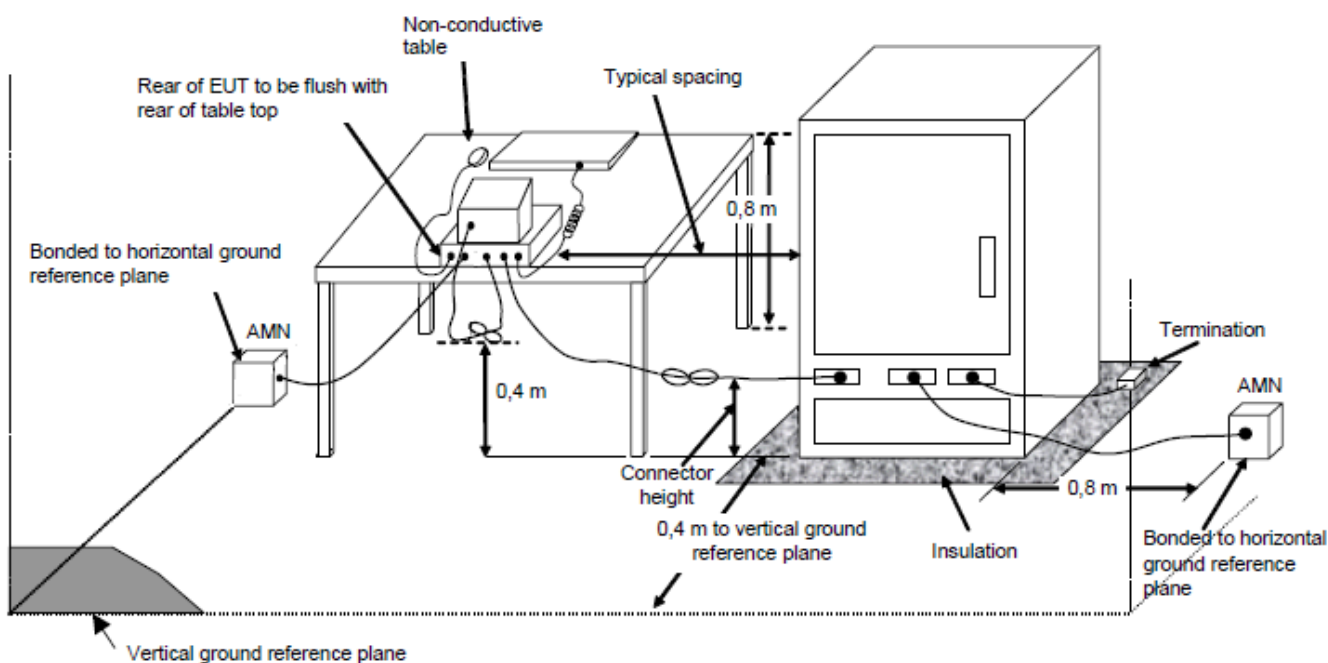

For the actual test configuration, please refer to the related Item – Photographs of the Test Configuration.

6.2 Radiated Emissions up to 1 GHz

- For the table-top EUT is placed on a 0.8 meter to the top of rotating table; for the floor standing EUT shall be insulated (by insulation of 12 mm) from the horizontal reference ground plane. The rotating table is rotated 360 degrees to determine the position of the highest radiation. If the equipment requires a dedicated ground connection, this shall be provided and bonded to the RGP.
- The EUT was set 10 meters away from the interference-receiving antenna, which was mounted on the top of a variable-height antenna tower.
- The antenna is a broadband antenna, and its height is varied from one meter to four meters above the ground to determine the maximum value of the field strength. Both horizontal and vertical polarizations of the antenna are set to make the measurement.
- For each suspected emission, the EUT was arranged to its worst case and then the antenna was tuned to heights from 1 meter to 4 meters and the rotatable table was turned from 0 degrees to 360 degrees to find the maximum reading.
- The test-receiver system was set to quasi-peak detect function and specified bandwidth with maximum hold mode when the test frequency is up to 1 GHz.

Note: The resolution bandwidth and video bandwidth of test receiver/spectrum analyzer is 120kHz for quasi-peak detection (QP) at frequency up to 1GHz.

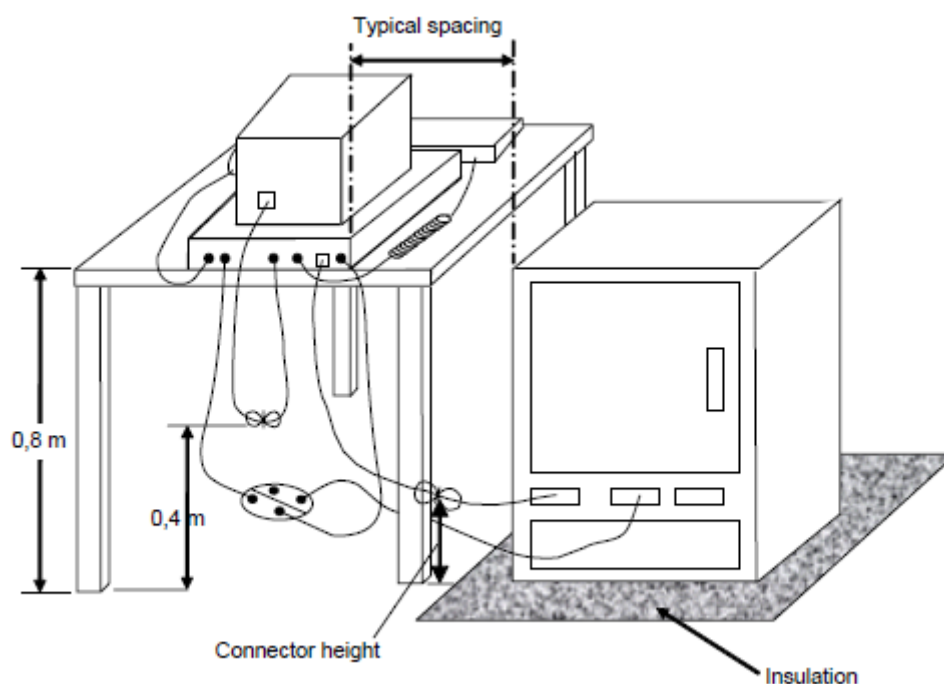

For the actual test configuration, please refer to the related Item – Photographs of the Test Configuration.

6.3 Radiated Emissions above 1 GHz

- For the table-top EUT is placed on a 0.8 meter to the top of rotating table; for the floor standing EUT shall be insulated (by insulation of 12 mm) from the horizontal reference ground plane. The rotating table is rotated 360 degrees to determine the position of the highest radiation. If the equipment requires a dedicated ground connection, this shall be provided and bonded to the RGP.
- The EUT was set $d = 3$ meters away from the interference-receiving antenna, which was mounted on the top of a variable-height antenna tower.
- The height of antenna can be varied from one meter to four meters, the height of adjustment depends on the EUT height and the antenna 3dB beamwidth both, to detect the maximum value of the field strength. Both horizontal and vertical polarizations of the antenna are set to make the measurement.
- For each suspected emission, the EUT was arranged to its worst case and then the antenna was tuned to heights and the rotatable table was turned from 0 degrees to 360 degrees to find the maximum reading.
- The spectrum analyzer system was set to peak and average detects function and specified bandwidth with maximum hold mode when the test frequency is above 1 GHz.

Note: The resolution bandwidth of test receiver/spectrum analyzer is 1MHz and video bandwidth is 3MHz for Peak detection (PK) at frequency above 1GHz. The resolution bandwidth of test receiver/spectrum analyzer is 1 MHz for Average detection (AV) at frequency above 1GHz.

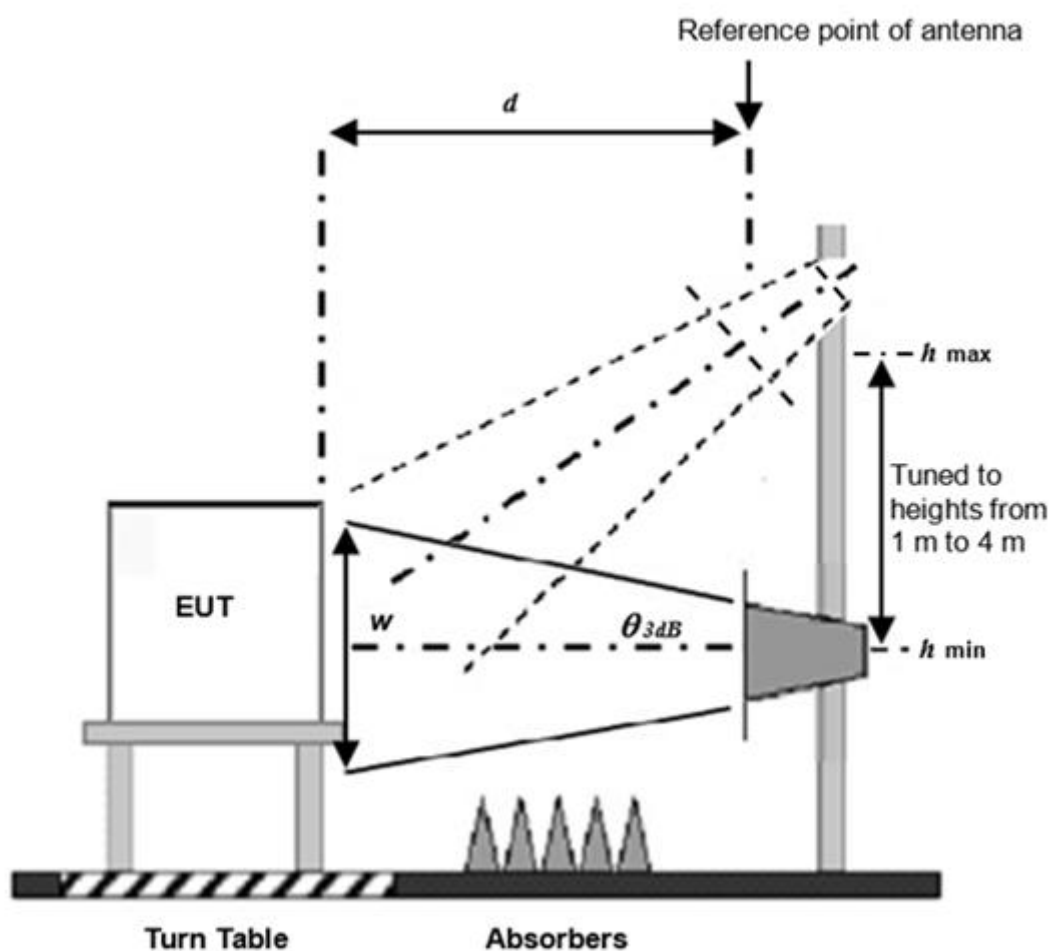

For the actual test configuration, please refer to the related item – Photographs of the Test Configuration.

7 Test Results of Test Item

7.1 Conducted Emissions from Power Ports

Mode A

| | | | |
|-----------------|------------------|------------------------------------------|--------------------------------------|
| Frequency Range | 150 kHz ~ 30 MHz | Detector Function & Resolution Bandwidth | Quasi-Peak (QP) / Average (AV), 9kHz |
| Input Power | 120 Vac, 60 Hz | Environmental Conditions | 21°C, 70% RH |
| Tested by | Adam Chen | | |

| Phase Of Power : Line (L) | | | | | | | | | | |
|---------------------------|-----------------|------------------------|----------------------|--------------|-----------------------|--------------|--------------|--------------|---------------|---------------|
| No | Frequency (MHz) | Correction Factor (dB) | Reading Value (dBuV) | | Emission Level (dBuV) | | Limit (dBuV) | | Margin (dB) | |
| | | | Q.P. | AV. | Q.P. | AV. | Q.P. | AV. | Q.P. | AV. |
| 1 | 0.15781 | 9.98 | 39.92 | 36.37 | 49.90 | 46.35 | 79.00 | 66.00 | -29.10 | -19.65 |
| 2 | 0.22812 | 9.98 | 37.69 | 27.43 | 47.67 | 37.41 | 79.00 | 66.00 | -31.33 | -28.59 |
| 3 | 2.26953 | 10.09 | 33.37 | 20.60 | 43.46 | 30.69 | 73.00 | 60.00 | -29.54 | -29.31 |
| 4 | 4.42188 | 10.14 | 32.39 | 23.79 | 42.53 | 33.93 | 73.00 | 60.00 | -30.47 | -26.07 |
| 5 | 9.51130 | 10.25 | 35.89 | 34.52 | 46.14 | 44.77 | 73.00 | 60.00 | -26.86 | -15.23 |
| 6 | 13.32814 | 10.30 | 37.24 | 29.45 | 47.54 | 39.75 | 73.00 | 60.00 | -25.46 | -20.25 |

Remarks:

1. Q.P. and AV. are abbreviations of quasi-peak and average individually.
2. The emission levels of other frequencies were very low against the limit.
3. Margin value = Emission level – Limit value
4. Correction factor = Insertion loss + Cable loss
5. Emission Level = Correction Factor + Reading Value

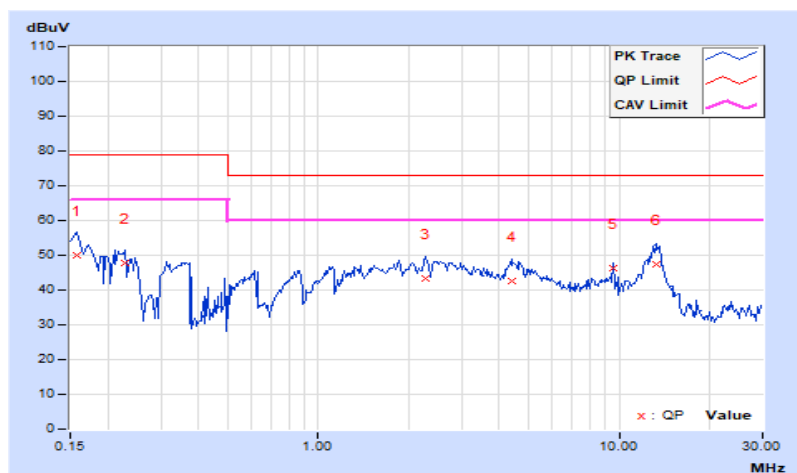

| | | | |
|------------------------|------------------|-----------------------------------------------------|--------------------------------------|
| Frequency Range | 150 kHz ~ 30 MHz | Detector Function & Resolution Bandwidth | Quasi-Peak (QP) / Average (AV), 9kHz |
| Input Power | 120 Vac, 60 Hz | Environmental Conditions | 21°C, 70% RH |
| Tested by | Adam Chen | | |

| Phase Of Power : Neutral (N) | | | | | | | | | | |
|------------------------------|-----------------|------------------------|----------------------|-------|-----------------------|-------|--------------|-------|-------------|--------|
| No | Frequency (MHz) | Correction Factor (dB) | Reading Value (dBuV) | | Emission Level (dBuV) | | Limit (dBuV) | | Margin (dB) | |
| | | | Q.P. | AV. | Q.P. | AV. | Q.P. | AV. | Q.P. | AV. |
| 1 | 0.15763 | 9.98 | 39.98 | 36.45 | 49.96 | 46.43 | 79.00 | 66.00 | -29.04 | -19.57 |
| 2 | 1.09766 | 10.01 | 32.92 | 19.02 | 42.93 | 29.03 | 73.00 | 60.00 | -30.07 | -30.97 |
| 3 | 1.83203 | 10.07 | 33.94 | 19.79 | 44.01 | 29.86 | 73.00 | 60.00 | -28.99 | -30.14 |
| 4 | 4.24609 | 10.13 | 31.57 | 23.03 | 41.70 | 33.16 | 73.00 | 60.00 | -31.30 | -26.84 |
| 5 | 9.50399 | 10.24 | 35.49 | 33.18 | 45.73 | 43.42 | 73.00 | 60.00 | -27.27 | -16.58 |
| 6 | 13.14453 | 10.28 | 31.40 | 23.96 | 41.68 | 34.24 | 73.00 | 60.00 | -31.32 | -25.76 |

Remarks:

1. Q.P. and AV. are abbreviations of quasi-peak and average individually.
2. The emission levels of other frequencies were very low against the limit.
3. Margin value = Emission level – Limit value
4. Correction factor = Insertion loss + Cable loss
5. Emission Level = Correction Factor + Reading Value

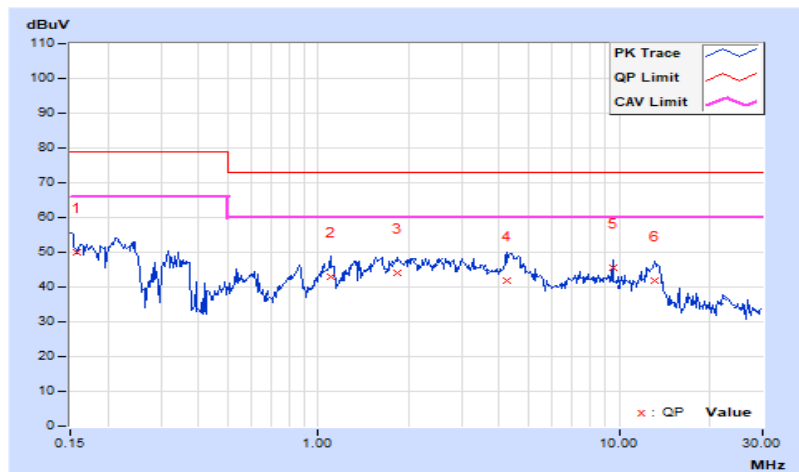

7.2 Radiated Emissions up to 1 GHz

Mode A

| | | | |
|-----------------|----------------|------------------------------------------|--------------------------|
| Frequency Range | 30 MHz ~ 1 GHz | Detector Function & Resolution Bandwidth | Quasi-Peak (QP), 120 kHz |
| Input Power | 120 Vac, 60 Hz | Environmental Conditions | 25°C, 75% RH |
| Tested By | Kobe Lu | | |

| Antenna Polarity & Test Distance : Horizontal at 10 m | | | | | | | | |
|-------------------------------------------------------|-----------------|-------------------------|----------------|-------------|--------------------|----------------------|------------------|--------------------------|
| No | Frequency (MHz) | Emission Level (dBuV/m) | Limit (dBuV/m) | Margin (dB) | Antenna Height (m) | Table Angle (Degree) | Raw Value (dBuV) | Correction Factor (dB/m) |
| 1 | 174.24 | 34.02 QP | 40.00 | -5.98 | 3.11 H | 59 | 50.80 | -16.78 |
| 2 | 222.51 | 36.01 QP | 40.00 | -3.99 | 4.00 H | 148 | 55.29 | -19.28 |
| 3 | 307.97 | 37.76 QP | 47.00 | -9.24 | 2.95 H | 300 | 52.81 | -15.05 |
| 4 | 461.97 | 35.59 QP | 47.00 | -11.41 | 1.88 H | 60 | 46.78 | -11.19 |
| 5 | 615.98 | 37.74 QP | 47.00 | -9.26 | 1.00 H | 38 | 45.36 | -7.62 |
| 6 | 769.98 | 36.81 QP | 47.00 | -10.19 | 1.95 H | 44 | 42.25 | -5.44 |

Remarks:

1. Emission Level(dBuV/m) = Raw Value(dBuV) + Correction Factor(dB/m)
2. Correction Factor(dB/m) = Antenna Factor (dB/m) + Cable Factor (dB)
– Pre-Amplifier Factor (dB)
3. Margin value = Emission level – Limit value
4. The other emission levels were very low against the limit.

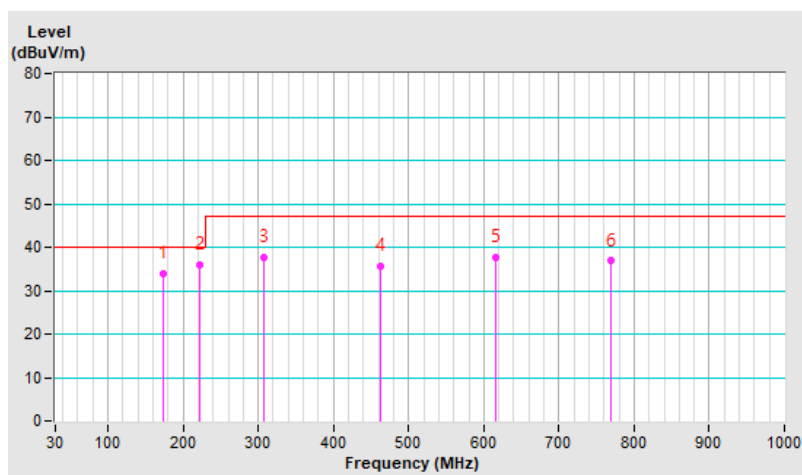

| | | | |
|-----------------|----------------|------------------------------------------|--------------------------|
| Frequency Range | 30 MHz ~ 1 GHz | Detector Function & Resolution Bandwidth | Quasi-Peak (QP), 120 kHz |
| Input Power | 120 Vac, 60 Hz | Environmental Conditions | 25°C, 75% RH |
| Tested By | Kobe Lu | | |

| Antenna Polarity & Test Distance : Vertical at 10 m | | | | | | | | |
|-----------------------------------------------------|-----------------|-------------------------|----------------|--------------|--------------------|----------------------|------------------|--------------------------|
| No | Frequency (MHz) | Emission Level (dBuV/m) | Limit (dBuV/m) | Margin (dB) | Antenna Height (m) | Table Angle (Degree) | Raw Value (dBuV) | Correction Factor (dB/m) |
| 1 | 51.33 | 37.35 QP | 40.00 | -2.65 | 1.83 V | 216 | 54.78 | -17.43 |
| 2 | 174.34 | 34.08 QP | 40.00 | -5.92 | 1.00 V | 300 | 50.89 | -16.81 |
| 3 | 220.63 | 38.11 QP | 40.00 | -1.89 | 1.00 V | 314 | 57.30 | -19.19 |
| 4 | 275.41 | 37.83 QP | 47.00 | -9.17 | 2.06 V | 332 | 53.70 | -15.87 |
| 5 | 418.55 | 34.24 QP | 47.00 | -12.76 | 3.95 V | 122 | 46.63 | -12.39 |
| 6 | 615.98 | 36.72 QP | 47.00 | -10.28 | 3.12 V | 97 | 44.45 | -7.73 |
| 7 | 769.98 | 36.08 QP | 47.00 | -10.92 | 2.88 V | 102 | 41.53 | -5.45 |
| 8 | 923.98 | 35.77 QP | 47.00 | -11.23 | 1.94 V | 61 | 39.67 | -3.90 |

Remarks:

1. Emission Level(dBuV/m) = Raw Value(dBuV) + Correction Factor(dB/m)
2. Correction Factor(dB/m) = Antenna Factor (dB/m) + Cable Factor (dB) – Pre-Amplifier Factor (dB)
3. Margin value = Emission level – Limit value
4. The other emission levels were very low against the limit.

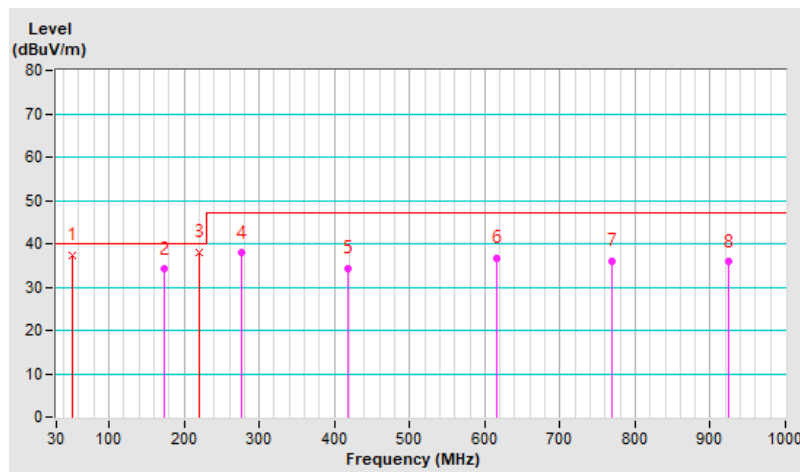

7.3 Radiated Emissions above 1 GHz

Mode A

| | | | |
|-----------------|----------------|------------------------------------------|--------------------------------|
| Frequency Range | 1 GHz ~ 7 GHz | Detector Function & Resolution Bandwidth | Peak (PK) / Average (AV), 1MHz |
| Input Power | 120 Vac, 60 Hz | Environmental Conditions | 25°C, 75% RH |
| Tested By | Vincent Lin | | |

| Antenna Polarity & Test Distance : Horizontal at 3 m | | | | | | | | |
|------------------------------------------------------|-----------------|-------------------------|----------------|--------------|--------------------|----------------------|------------------|--------------------------|
| No | Frequency (MHz) | Emission Level (dBuV/m) | Limit (dBuV/m) | Margin (dB) | Antenna Height (m) | Table Angle (Degree) | Raw Value (dBuV) | Correction Factor (dB/m) |
| 1 | 2398.89 | 56.52 PK | 80.00 | -23.48 | 1.06 H | 290 | 58.11 | -1.59 |
| 2 | 2398.89 | 40.31 AV | 60.00 | -19.69 | 1.06 H | 290 | 41.90 | -1.59 |
| 3 | 4800.47 | 51.20 PK | 80.00 | -28.80 | 1.53 H | 34 | 47.28 | 3.92 |
| 4 | 4800.47 | 35.88 AV | 60.00 | -24.12 | 1.53 H | 34 | 31.96 | 3.92 |
| 5 | 6000.02 | 66.53 PK | 80.00 | -13.47 | 2.60 H | 193 | 61.11 | 5.42 |
| 6 | 6000.02 | 59.32 AV | 60.00 | -0.68 | 2.60 H | 193 | 53.90 | 5.42 |

Remarks:

1. Emission Level(dBuV/m) = Raw Value(dBuV) + Correction Factor(dB/m)
2. Correction Factor(dB/m) = Antenna Factor (dB/m) + Cable Factor (dB)
– Pre-Amplifier Factor (dB)
3. Margin value = Emission level – Limit value
4. The other emission levels were very low against the limit.

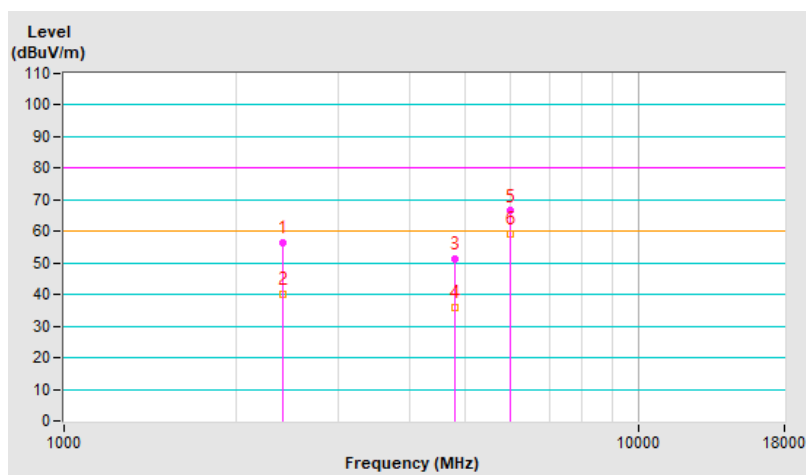

| | | | |
|------------------------|----------------|-----------------------------------------------------|--------------------------------|
| Frequency Range | 1 GHz ~ 7 GHz | Detector Function & Resolution Bandwidth | Peak (PK) / Average (AV), 1MHz |
| Input Power | 120 Vac, 60 Hz | Environmental Conditions | 25°C, 75% RH |
| Tested By | Vincent Lin | | |

| Antenna Polarity & Test Distance : Vertical at 3 m | | | | | | | | |
|----------------------------------------------------|-----------------|-------------------------|----------------|-------------|--------------------|----------------------|------------------|--------------------------|
| No | Frequency (MHz) | Emission Level (dBuV/m) | Limit (dBuV/m) | Margin (dB) | Antenna Height (m) | Table Angle (Degree) | Raw Value (dBuV) | Correction Factor (dB/m) |
| 1 | 2396.74 | 60.02 PK | 80.00 | -19.98 | 1.05 V | 223 | 61.62 | -1.60 |
| 2 | 2396.74 | 44.68 AV | 60.00 | -15.32 | 1.05 V | 223 | 46.28 | -1.60 |
| 3 | 4800.16 | 52.32 PK | 80.00 | -27.68 | 2.69 V | 0 | 48.40 | 3.92 |
| 4 | 4800.16 | 40.53 AV | 60.00 | -19.47 | 2.69 V | 0 | 36.61 | 3.92 |
| 5 | 5999.99 | 66.15 PK | 80.00 | -13.85 | 2.59 V | 174 | 60.73 | 5.42 |
| 6 | 5999.99 | 59.19 AV | 60.00 | -0.81 | 2.59 V | 174 | 53.77 | 5.42 |

Remarks:

1. Emission Level(dBuV/m) = Raw Value(dBuV) + Correction Factor(dB/m)
2. Correction Factor(dB/m) = Antenna Factor (dB/m) + Cable Factor (dB) – Pre-Amplifier Factor (dB)
3. Margin value = Emission level – Limit value
4. The other emission levels were very low against the limit.

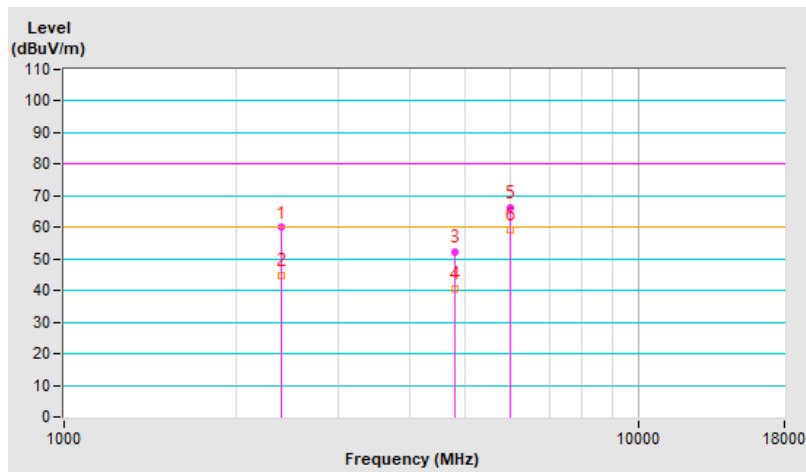

8 Pictures of Test Arrangements

8.1 Conducted Emissions from Power Ports

Mode A

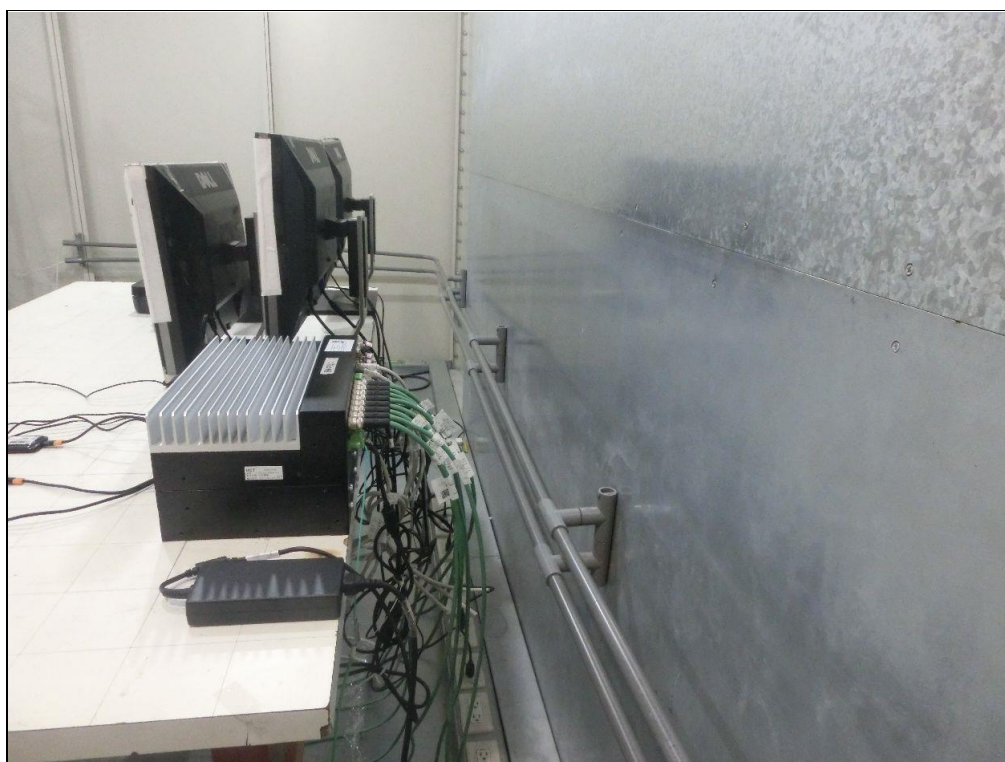

8.2 Radiated Emissions up to 1 GHz

Mode A



8.3 Radiated Emissions above 1 GHz

Mode A

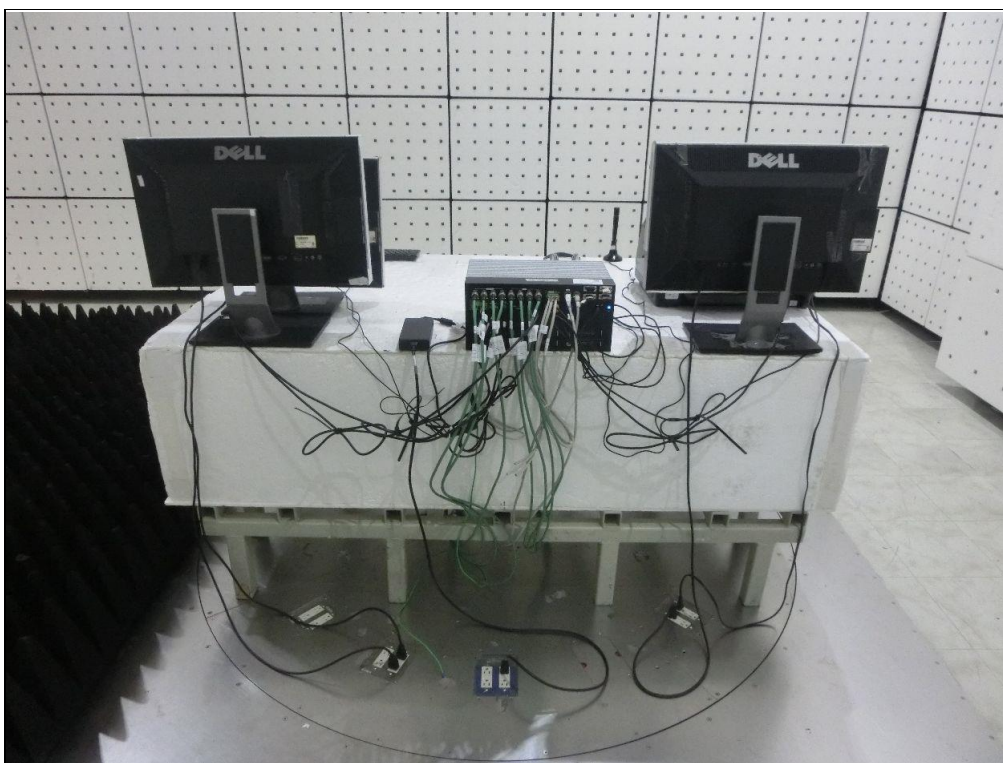

9 Information of the Testing Laboratories

We, Bureau Veritas Consumer Products Services (H.K.) Ltd., Taoyuan Branch, were founded in 1988 to provide our best service in EMC, Radio, Telecom and Safety consultation. Our laboratories are FCC recognized accredited test firms and accredited according to ISO/IEC 17025.

If you have any comments, please feel free to contact us at the following:

Lin Kou EMC/RF Lab

Tel: 886-2-26052180

Fax: 886-2-26051924

Hsin Chu EMC/RF/Telecom Lab

Tel: 886-3-6668565

Fax: 886-3-6668323

Hwa Ya EMC/RF/Safety Lab

Tel: 886-3-3183232

Fax: 886-3-3270892

Email: service.adt@bureauveritas.com

Web Site: <http://ee.bureauveritas.com.tw>

The address and road map of all our labs can be found in our web site also.

--- END ---